

Accuphase

INTEGRATED STEREO AMPLIFIER

E-303X

- Power output stage employing MOS FETs in a triple push-pull configuration
- MC input to output directly coupled in a straight DC configuration
- Complementary-symmetry push-pull design based on Accuphase's original circuitry



All-stage push-pull circuitry. All signal paths directly coupled. MOS FETs in a triple push-pull configuration can drive even

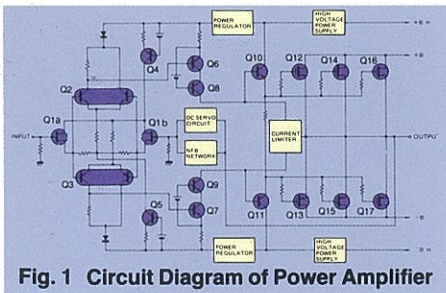

Fig. 1 Circuit Diagram of Power Amplifier

Though an integrated amplifier, the E-303X incorporates much of the sophisticated technology and quality circuit components originally developed for use in Accuphase's separate amplifiers. Its resulting high-level performance permits the E-303X to handle even purely digital audio sources, such as Pulse Code Modulation (PCM) recordings and Compact Discs.

The power output stage of the E-303X uses high-speed MOS FETs in a triple push-pull configuration to deliver one of the highest outputs of any integrated amplifier: 150 watts per channel (into 8 ohms, from 20–20,000 Hz, with no more than 0.01% THD). This means the E-303X has more than enough power to drive even low impedance loads. For example, output into 2 ohms is an enormous 250 watts per channel.

The circuitry is based on Accuphase's original complementary-symmetrical push-pull design and generous employment of the cascode push-pull configuration realizes ideal high-frequency characteristics. This design raises overall performance to the highest level possible. Furthermore, all amplification stages from MC (Moving Coil Cartridge) input to output are directly coupled in a straight DC (capacitorless) configuration to provide amplification with a minimum of coloration.

The E-303X also has an input impedance selector to assure optimum performance with all sorts of MC cartridges. Other features include tone controls, automatic loudness compensation for listening at low-volume levels, abundant facilities for tape decks, and a complete range of input terminals to accommodate even large, multi-component audio systems. Inside and out, the E-303X is fully equipped to meet the increasingly complex needs of today's high quality audio components.

1 Triple push-pull MOS FET power output stage delivers 150 watts of clean power per channel.

The power output stage employs a triple push-pull configuration using six MOS FETs having a generous P_D (maximum power dissipation) of 600 watts. MOS FETs have already been used in a great number of Accuphase power amplifiers where they have gained a solid reputation for their sonic purity. For your reference, the main advantages of MOS FETs are described later.

The circuit diagram for the power amp section is shown in Figure 1. As you can see, the design is clean and allows easy operation. The preliminary stage is a differential push-pull circuit consisting of transistors Q2 and Q3. Next comes a cascode push-pull circuit with transistors Q6–Q9, and the MOS FETs Q12–Q17 are driven by the Q10 and Q11 pre-drivers. In this circuit design, the most important point affecting performance is the cascode push-pull circuits respectively composed of Q6 and Q8, and Q7 and Q9.

The cascode configuration is most often used in the radio frequency amplifier circuits of tuners because this type of circuit is not plagued by the Miller effect even when handling high frequencies. Along with the cascode's high gain, this makes a significant contribution to improving performance in all power amp stages.

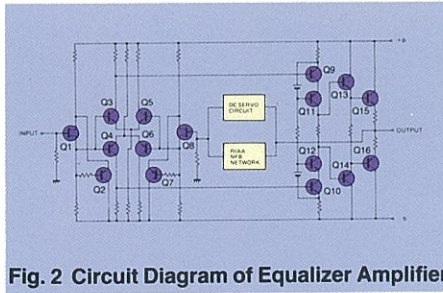

Fig. 2 Circuit Diagram of Equalizer Amplifier

2 Large power supply and powerful output stage drive even 2-ohm speakers with ease.

The nominal impedance of a speaker is nothing more than a representative value obtained at a specific frequency. The actual impedance fluctuates a lot across the speaker's frequency range. Consequently, the actual impedance of a speaker system having a nominal impedance of 4 ohms may drop to as low as 3 ohms or even 2 ohms for some frequency ranges. Impedance can also drop momentarily when certain kinds of transient signals are reproduced. Because of this, only an amplifier capable of handling these low impedances can drive a speaker system accurately.

A directly coupled solid-state amplifier generates increasingly large currents in proportion to decreases of the load impedance, which can result in destruction of output elements. Because amplifier output in general can handle currents only up to a certain strength, some sort of protection circuitry must be provided to prevent currents above a certain level from reaching the outputs (and speaker). As a result, the maximum output level for low impedance loads is severely restricted with these amplifiers.

On the other hand, the power amp section of the E-303X has a high power output stage and a generous power supply section to supply very high outputs safely when necessary. As a result, the E-303X can be connected to low impedance speakers. Into 2 ohms, for example, the E-303X can output an awesome 250 watts per channel.

3 Directly coupled circuitry with DC servo preserves MC signal purity from input to output.

The E-303X employs a virtually ideal configuration in which the MC head amp, equalizer amp, high-level amp and power amp are all directly coupled. This construction guarantees that the original signal is amplified and output in a virtually unaltered state to provide an extremely high level of fidelity. To eliminate DC drift completely, a problem that exists in all directly coupled amps, a powerful DC servo is used to stabilize each unit amp.

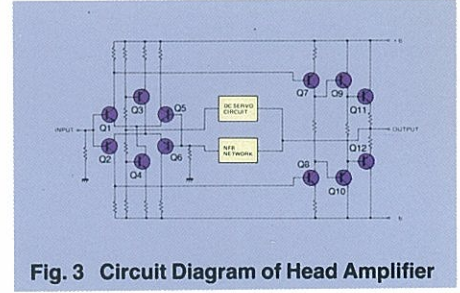

Fig. 3 Circuit Diagram of Head Amplifier

4 All-stage push-pull EQ amp with differential amplifier input, cascode pre-drive, and Darlington pair output.

Disc sound quality largely depends on the equalizer (EQ) amp, because the EQ amp determines RIAA characteristics. The circuit diagram of the E-303X's EQ amp is shown in Figure 2. The input stage is a differential amplifier with an FET buffer, the pre-drive stage is a cascode circuit composed of Q9–Q12, and final stage is a Darlington pair output composed of Q13–Q16. Each stage employs push-pull circuitry.

The pre-drive stage cascode connection consists of two pairs of transistors, Q9 and Q11, and Q10 and Q12, respectively. As stated in Section 1 describing the power amp, these cascode connections have excellent high-frequency characteristics to offer stable, low-distortion performance over a wide frequency range.

The Darlington pair output is also composed of two pairs of transistors, Q13 and Q15, and Q14 and Q16, respectively. Because the input impedance of this stage can be raised to a value multiplied by the h_{FE} (static forward current transfer ratio) of Q13 and Q14, pre-drive stage performance is not easily affected by the load. This makes possible the creation of an amp having low distortion and excellent stability.

In this manner, Accuphase has put together a series of outstanding individual circuits in a completely push-pull configuration to raise amplifier performance to the highest level possible before adding negative feedback and to obtain the pure quality sound.

Power supplies are provided by constant voltage power supplies on each printed circuit board to reinforce operation further.

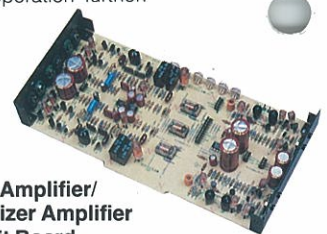

• Head Amplifier/Equalizer Amplifier Circuit Board

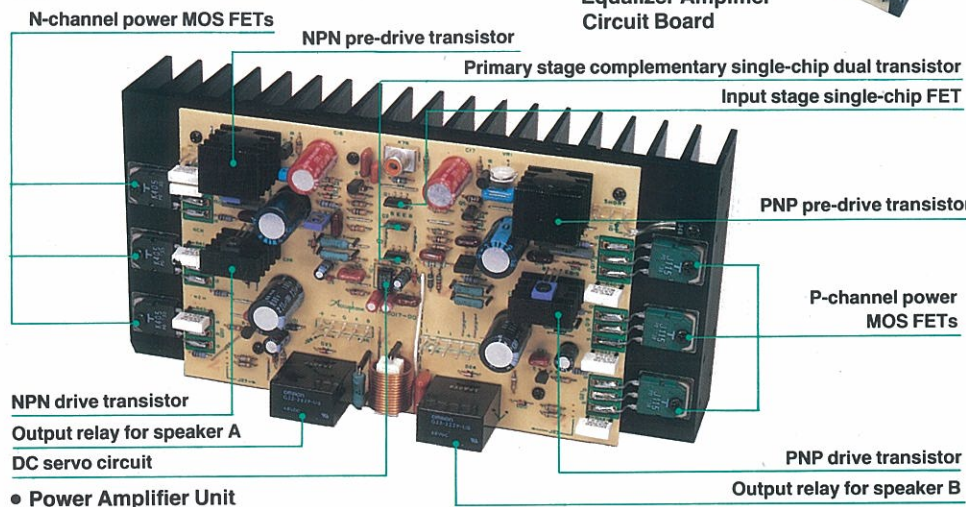

• Power Amplifier Unit

- N-channel power MOS FETs
- NPN pre-drive transistor
- Primary stage complementary single-chip dual transistor
- Input stage single-chip FET
- PNP pre-drive transistor
- P-channel power MOS FETs
- NPN drive transistor
- Output relay for speaker A
- DC servo circuit
- PNP drive transistor
- Output relay for speaker B

in a straight DC servo configuration.
2-ohm load, delivering 250W/ch.

Accuphase **E-303X**
INTEGRATED STEREO AMPLIFIER

5 Differential amplifier input + Darlington pair output all-stage push-pull head amp guarantees optimum performance with all kinds of MC cartridges.

The E-303X has a complete MC head amp that even has its own amplifier with flat characteristics placed before the equalizer amplifier. The circuit diagram is shown in Figure 3. Because there are no capacitors, the delicate signals received from the MC cartridge can be sent directly to the input circuit. To prevent the generation of noise, carefully selected low-noise circuit elements are employed, and the negative feedback loop has a low impedance.

Because MC signals are so weak, even noise from the constant voltage circuit of the MC head amp's power supply can seriously degrade the S/N ratio of the signal path. In the E-303X, all elements used in the constant voltage power supply have been carefully selected to guarantee a completely low noise design.

The gain of 30 dB, a high value for a head amp, means that even low output MC cartridges can be produced at a sufficient volume level. To be compatible with the wide range of MC cartridge input impedances and to permit fine control of sound quality, the E-303X has a 3-stage impedance selector (10, 30, and 100 ohms). For cartridges having an impedance of around 3 ohms, a load impedance of 10 or 30 ohms is best. Cartridges having an impedance of more than 10 ohms are suited to 30- or 100-ohm setting.

6 Logic controlled relays keeps the signal path as straight and short as possible.

The roundabout signal paths necessitated by switching connections for the input source, tape monitor, and other mode selections can degrade high-frequency sound quality and lead to an unstable operation. In the E-303X, the input terminals are coupled directly to a printed circuit board. Relays located near this board then route the signal over the shortest possible path according to orders from a logic circuit.

The relays are highly dependable crossbar-twin type relays developed especially for use with low-level audio signals. Their contact points are gold-plated silver palladium alloy. The relays are sealed in airtight containers to guarantee outstanding durability and reliability.

7 1.5 dB step tone controls with turnover selector.

Switch type tone controls are employed to permit adjusting response in discrete steps of 1.5 dB. Fine control like this means you can obtain precisely the response curve desired in almost any situation. The bass turnover frequency can be set to either 200 Hz or 500 Hz, the treble turnover frequency to either 2 kHz or 7 kHz.

8 3-step loudness compensator provides well-balanced low-volume sound.

At low-volume level, very low and very high frequencies are more difficult to hear than the frequencies in between. Consequently, some degree of compensation, or boost, in these ranges is required to preserve a feeling of flat response at low-volume level. Furthermore, the amount of compensation must vary automatically according to the volume setting to maintain the feeling of flat, balanced response.

To do this, the E-303X has a 3-step loudness compensation system that lets you adjust response according to the acoustics of the listening room, speaker system characteristics, and personal preferences.

9 Direct readout peak power meters

The power meters use a logarithmic peak scale to permit direct readout of peak power outputs in dB and watts. The soft-blue transparent illumination

adds an extra touch of elegance to the front panel and your listening room.

10 Tape monitor and dubbing switches

Two tape decks can be connected to the E-303X at once for convenience and versatility. The tape monitor switch permits monitoring the signal being recorded, and dubbing switch permits copying (dubbing) a tape from one deck to the other regardless of the input selector's position.

11 Other functions and facilities

The E-303X is also equipped with many other useful features.

A subsonic filter can be activated to eliminate subsonic noise generated by record warps.

An attenuator allows lowering the volume level without disturbing the volume control.

A speaker switch lets you switch between two speaker systems or use both at once.

A stereo/mono mode switch permits switching to monophonic reproduction to check for correct phase response between the left and right speaker systems.

These and many more controls mean the E-303X is fully prepared to handle any listening or recording need. It even has two extra pairs of line input terminals (in addition to the TUNER terminals) to allow connection of a Compact Disc player, video cassette recorder, or other components without having to disconnect any other component to make room.

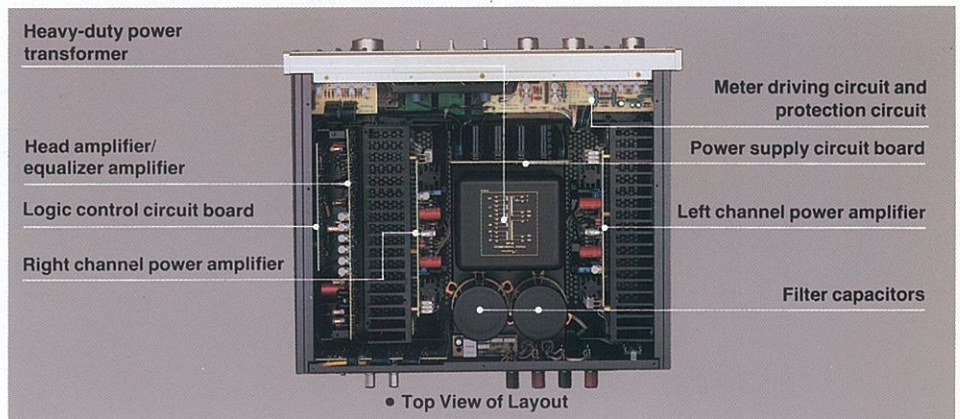

"POWER MOS FETs"

The special characteristics of MOS FETs (Metal-Oxide Semiconductor Field Effect Transistors) that make them the most ideal power amplification device had been known for a number of years by those concerned in the audio world. However, their availability did not take place for a long time because of technical production difficulties that delayed their commercial feasibility. A breakthrough was finally made here in Japan ahead of the world in developing a practical means of producing high power MOS FETs, and these remarkable devices have now become available, and are opening the way for further progress in audio amplification.

The following is a brief summary of some of the advantages of MOS FETs in power amplifier applications.

SUPERIOR HIGH SPEED CHARACTERISTICS ENSURE LOW DISTORTION

A harmful notching distortion caused by a phenomenon known as carrier storage effect occurs at the P-channel and N-channel circuit junction of bipolar transistors when they are used in normal push-pull formation. This distortion occurs especially in the high frequency range, and bipolar transistors must be worked in Class-A operation to eliminate it completely.

This carrier storage effect and notching distortion are not encountered with MOS FETs because of their superior high-speed switching characteristics, so the use of MOS FETs ensures very excellent, low distortion characteristics.

VOLTAGE CONTROLLED MOS FETs PERMIT SUPERIOR DRIVER STAGE DESIGN

MOS FET power transistors have a high input-impedance characteristic and are voltage controlled devices which require only low current, signal voltages fed to their input to deliver a high power output, unlike bipolar transistors that must be driven by high current, more powerful signals. This means that more ideal operating conditions can be designed for the preceding driver stage when MOS FETs are used in the final stage. Because of the low current requirements, superior low power devices can be utilized. Class-A operation can also be utilized for driver stage amplifiers more easily and improve the overall performance of the amplifier.

MOS FETs PRODUCE HIGH GAIN

The high gain attainable from only one stage of complementary push-pull Power MOS FETs is equivalent to the gain obtained with two or three bipolar transistor amplifier stages. The reduced number of stages for MOS FET amplifiers simplifies signal path circuitry and helps to create a superior power amplifier with higher stability and improved characteristics.

SUPERIOR HIGH FREQUENCY PERFORMANCE

It is advantageous to provide adequate wideband, high frequency characteristics within the NF (Negative Feedback) loop in audio amplification circuits where large amounts of negative feedback are required. This helps to prevent TIM (Transient Intermodulation Distortion) and obtain a more accurate, faithful reproduction of music. The wideband characteristics of MOS FETs make this possible, and helps to prevent TIM more effectively.

LINEARITY

Compared with Junction-type FETs, MOS FETs have a wider linear range which means that superior performance can be obtained with smaller bias currents and less heat generation, a desirable characteristic for power amplifier devices. In this respect, bipolar transistors are very excellent devices also.

BUILT-IN PROTECTION AGAINST OVERHEATING

MOS FETs have a Negative Temperature Coefficient in the high current area, a characteristic which basically differs from bipolar transistors. This helps to protect itself from damage in case of trouble. For example, if an abnormal current flow occurs resulting from some circuit breakdown, a sudden rise in pellet temperature will cause this negative temperature coefficient of the MOS FET to decrease current flow, reduce heat and protect itself from damage. A similar breakdown may cause thermal runaway with bipolar transistors which would require protective countermeasures and special operational care.

As explained above, MOS FETs have many advantages. However, if we are to mention a weak point, it is that they are costly.

Nevertheless, Accuphase has adopted MOS FETs because of their excellent performance characteristics which, we firmly believe, is well worth the extra cost.

Although certain weak points of bipolar transistors were described in the above comparison with MOS FET devices, we must add that due to constant progress in circuit design technology, there are certain well-designed bipolar amplifiers that are equal in performance, if not superior, to some MOS FET Amplifiers.

- 1 **LOUDNESS COMPENSATOR switch**
OFF, COMP1, COMP2, COMP3
- 2 **Speaker selector switches**
OFF, A, B, A+B
- 3 **BASS control**
10-step-rotary switch
- 4 **TREBLE control**
10-step-rotary switch
- 5 **Power level meter for left channel**
- 6 **dB scale**
- 7 **Wattage scale**
- 8 **Power level meter for right channel**
- 9 **VOLUME control**
- 10 **MC cartridge LOAD impedance selector** 10 Ω , 30 Ω , 100 Ω
- 11 **HEAD AMPLIFIER ON/OFF switch**
- 12 **POWER switch**
- 13 **Stereo headPHONES jack**
- 14 **Bass turnover frequency selectors** 200Hz/500Hz
- 15 **TONE CONTROL ON/OFF switch**
- 16 **Treble turnover frequency selectors** 2 kHz/7 kHz
- 17 **Tape monitor/recording output ON/OFF selector switch**
- 18 **TAPE COPYING control**
- 19 **BALANCE control**
- 20 **ATTENUATOR** -20dB
- 21 **MODE selector switch**

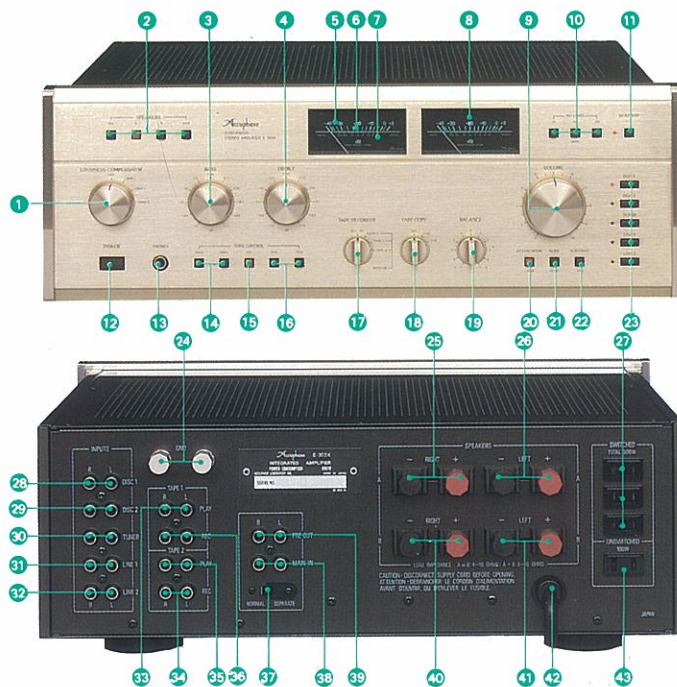

- 22 **SUBSONIC filter** 17Hz, -12dB/oct
- 23 **Input selector** DISC-1, DISC-2, TUNER, LINE-1, LINE-2
- 24 **GND terminals**
- 25 **RIGHT channel output terminals for speaker A**
- 26 **LEFT channel output terminals for speaker A**
- 27 **AC outlet (operates in connection with power switch)**
- 28 **DISC 1 input jack**
- 29 **DISC 2 input jack**
- 30 **TUNER input jack**
- 31 **LINE 1 input jack**
- 32 **LINE 2 input jack**
- 33 **TAPE 1 input jack**
- 34 **TAPE 2 recording output jack**
- 35 **TAPE 2 input jack**
- 36 **TAPE 1 recording output jack**
- 37 **Preamplifier/power amplifier separation slide switch**
- 38 **Power amplifier input jack**
- 39 **Preamplifier output jack**
- 40 **RIGHT channel output terminals for speaker B**
- 41 **LEFT channel output terminals for speaker B**
- 42 **AC power cord**
- 43 **AC outlet (operates independent of power switch)**

GUARANTY SPECIFICATIONS

● PERFORMANCE GUARANTY:

All Accuphase product specifications are guaranteed as stated.

● POWER OUTPUT: (EIA)

Both channels driven from 20 Hz to 20,000 Hz with no more than 0.01% total harmonic distortion:
200 watts per channel, min. RMS, at 4 ohms
150 watts per channel, min. RMS, at 8 ohms
75 watts per channel, min. RMS, at 16 ohms

● TOTAL HARMONIC DISTORTION: (EIA)

From 20 Hz to 20,000 Hz at any power output from 1/4 watt to rated power: 0.01% max., at a load of more than 4 ohms

● INTERMODULATION DISTORTION: (EIA)

Will not exceed 0.005% at rated power output for any combination of frequencies between 20 Hz and 20,000 Hz at 8 ohms

● FREQUENCY RESPONSE: (EIA)

Main Amp Input: 20 Hz to 20,000 Hz; +0, -0.2 dB at rated power output
1.5 Hz to 150,000 Hz; +0, -3.0 dB at 1 watt power output
High-Level Input: 20 Hz to 20,000 Hz; +0, -0.2 dB at rated power output
Low-Level Input: 20 Hz to 20,000 Hz; +0.2, -0.2 dB at rated power output

● DAMPING FACTOR: (EIA)

150, 8-ohm load at 50 Hz

● INPUT SENSITIVITY AND IMPEDANCE:

Input Terminal	Sensitivity		Impedance
	Rated Output	EIA (1W Output)	
DISC (HEAD AMP OFF/MM)	2.7 mV	0.22 mV	47 k Ω
DISC (HEAD AMP ON/MC)	0.085 mV	0.007 mV	10/30/100 Ω
TUNER, LINE, TAPE, PLAY	170 mV	13.9 mV	20 k Ω
MAIN AMP INPUT	1.4V	0.12V	20 k Ω

● MAXIMUM INPUT FOR DISC INPUT: (0.005% THD)

HEAD AMP OFF; 300 mV RMS at 1 kHz

HEAD AMP ON; 9.5 mV RMS at 1 kHz

● OUTPUT LEVEL AND IMPEDANCE:

PREAMP; 1.4V at rated input level, 200 ohms

TAPE REC; 170 mV at rated input level, 200 ohms

HEADPHONE JACK; For listening with low impedance (4-100 ohms) dynamic stereo headphones

For listening with low impedance (4-100 ohms) dynamic stereo headphones

For listening with low impedance (4-100 ohms) dynamic stereo headphones

For listening with low impedance (4-100 ohms) dynamic stereo headphones

For listening with low impedance (4-100 ohms) dynamic stereo headphones

For listening with low impedance (4-100 ohms) dynamic stereo headphones

For listening with low impedance (4-100 ohms) dynamic stereo headphones

For listening with low impedance (4-100 ohms) dynamic stereo headphones

For listening with low impedance (4-100 ohms) dynamic stereo headphones

For listening with low impedance (4-100 ohms) dynamic stereo headphones

For listening with low impedance (4-100 ohms) dynamic stereo headphones

For listening with low impedance (4-100 ohms) dynamic stereo headphones

For listening with low impedance (4-100 ohms) dynamic stereo headphones

For listening with low impedance (4-100 ohms) dynamic stereo headphones

For listening with low impedance (4-100 ohms) dynamic stereo headphones

For listening with low impedance (4-100 ohms) dynamic stereo headphones

For listening with low impedance (4-100 ohms) dynamic stereo headphones

For listening with low impedance (4-100 ohms) dynamic stereo headphones

For listening with low impedance (4-100 ohms) dynamic stereo headphones

For listening with low impedance (4-100 ohms) dynamic stereo headphones

For listening with low impedance (4-100 ohms) dynamic stereo headphones

For listening with low impedance (4-100 ohms) dynamic stereo headphones

For listening with low impedance (4-100 ohms) dynamic stereo headphones

For listening with low impedance (4-100 ohms) dynamic stereo headphones

For listening with low impedance (4-100 ohms) dynamic stereo headphones

For listening with low impedance (4-100 ohms) dynamic stereo headphones

For listening with low impedance (4-100 ohms) dynamic stereo headphones

For listening with low impedance (4-100 ohms) dynamic stereo headphones

For listening with low impedance (4-100 ohms) dynamic stereo headphones

For listening with low impedance (4-100 ohms) dynamic stereo headphones

For listening with low impedance (4-100 ohms) dynamic stereo headphones

For listening with low impedance (4-100 ohms) dynamic stereo headphones

For listening with low impedance (4-100 ohms) dynamic stereo headphones

For listening with low impedance (4-100 ohms) dynamic stereo headphones

For listening with low impedance (4-100 ohms) dynamic stereo headphones

For listening with low impedance (4-100 ohms) dynamic stereo headphones

For listening with low impedance (4-100 ohms) dynamic stereo headphones

For listening with low impedance (4-100 ohms) dynamic stereo headphones

For listening with low impedance (4-100 ohms) dynamic stereo headphones

For listening with low impedance (4-100 ohms) dynamic stereo headphones

For listening with low impedance (4-100 ohms) dynamic stereo headphones

For listening with low impedance (4-100 ohms) dynamic stereo headphones

For listening with low impedance (4-100 ohms) dynamic stereo headphones

For listening with low impedance (4-100 ohms) dynamic stereo headphones

For listening with low impedance (4-100 ohms) dynamic stereo headphones

For listening with low impedance (4-100 ohms) dynamic stereo headphones

For listening with low impedance (4-100 ohms) dynamic stereo headphones

For listening with low impedance (4-100 ohms) dynamic stereo headphones

For listening with low impedance (4-100 ohms) dynamic stereo headphones

For listening with low impedance (4-100 ohms) dynamic stereo headphones

For listening with low impedance (4-100 ohms) dynamic stereo headphones

For listening with low impedance (4-100 ohms) dynamic stereo headphones

For listening with low impedance (4-100 ohms) dynamic stereo headphones

For listening with low impedance (4-100 ohms) dynamic stereo headphones

For listening with low impedance (4-100 ohms) dynamic stereo headphones

For listening with low impedance (4-100 ohms) dynamic stereo headphones

For listening with low impedance (4-100 ohms) dynamic stereo headphones

For listening with low impedance (4-100 ohms) dynamic stereo headphones

For listening with low impedance (4-100 ohms) dynamic stereo headphones

For listening with low impedance (4-100 ohms) dynamic stereo headphones

● POWER REQUIREMENT:

Voltage selection by rewiring for 100, 117, 220, 240V

50/60 Hz operation

Consumption;

90 watts at zero signal output, 550 watts at rated power output into 8-ohm load

90 watts at zero signal output, 550 watts at rated power output into 8-ohm load

90 watts at zero signal output, 550 watts at rated power output into 8-ohm load

90 watts at zero signal output, 550 watts at rated power output into 8-ohm load

90 watts at zero signal output, 550 watts at rated power output into 8-ohm load

90 watts at zero signal output, 550 watts at rated power output into 8-ohm load

90 watts at zero signal output, 550 watts at rated power output into 8-ohm load

90 watts at zero signal output, 550 watts at rated power output into 8-ohm load

90 watts at zero signal output, 550 watts at rated power output into 8-ohm load

90 watts at zero signal output, 550 watts at rated power output into 8-ohm load

90 watts at zero signal output, 550 watts at rated power output into 8-ohm load

90 watts at zero signal output, 550 watts at rated power output into 8-ohm load

90 watts at zero signal output, 550 watts at rated power output into 8-ohm load

90 watts at zero signal output, 550 watts at rated power output into 8-ohm load

90 watts at zero signal output, 550 watts at rated power output into 8-ohm load

90 watts at zero signal output, 550 watts at rated power output into 8-ohm load

90 watts at zero signal output, 550 watts at rated power output into 8-ohm load

90 watts at zero signal output, 550 watts at rated power output into 8-ohm load

90 watts at zero signal output, 550 watts at rated power output into 8-ohm load

90 watts at zero signal output, 550 watts at rated power output into 8-ohm load

90 watts at zero signal output, 550 watts at rated power output into 8-ohm load

90 watts at zero signal output, 550 watts at rated power output into 8-ohm load

90 watts at zero signal output, 550 watts at rated power output into 8-ohm load

90 watts at zero signal output, 550 watts at rated power output into 8-ohm load

90 watts at zero signal output, 550 watts at rated power output into 8-ohm load

90 watts at zero signal output, 550 watts at rated power output into 8-ohm load

90 watts at zero signal output, 550 watts at rated power output into 8-ohm load

90 watts at zero signal output, 550 watts at rated power output into 8-ohm load

90 watts at zero signal output, 550 watts at rated power output into 8-ohm load

90 watts at zero signal output, 550 watts at rated power output into 8-ohm load

90 watts at zero signal output, 550 watts at rated power output into 8-ohm load

90 watts at zero signal output, 550 watts at rated power output into 8-ohm load

90 watts at zero signal output, 550 watts at rated power output into 8-ohm load

90 watts at zero signal output, 550 watts at rated power output into 8-ohm load

90 watts at zero signal output, 550 watts at rated power output into 8-ohm load

90 watts at zero signal output, 550 watts at rated power output into 8-ohm load

90 watts at zero signal output, 550 watts at rated power output into 8-ohm load

90 watts at zero signal output, 550 watts at rated power output into 8-ohm load

90 watts at zero signal output, 550 watts at rated power output into 8-ohm load

90 watts at zero signal output, 550 watts at rated power output into 8-ohm load

90 watts at zero signal output, 550 watts at rated power output into 8-ohm load

90 watts at zero signal output, 550 watts at rated power output into 8-ohm load

90 watts at zero signal output, 550 watts at rated power output into 8-ohm load

90 watts at zero signal output, 550 watts at rated power output into 8-ohm load

90 watts at zero signal output, 550 watts at rated power output into 8-ohm load

90 watts at zero signal output, 550 watts at rated power output into 8-ohm load

90 watts at zero signal output, 550 watts at rated power output into 8-ohm load

90 watts at zero signal output, 550 watts at rated power output into 8-ohm load

90 watts at zero signal output, 550 watts at rated power output into 8-ohm load

90 watts at zero signal output, 550 watts at rated power output into 8-ohm load

90 watts at zero signal output, 550 watts at rated power output into 8-ohm load

90 watts at zero signal output, 550 watts at rated power output into 8-ohm load

90 watts at zero signal output, 550 watts at rated power output into 8-ohm load

90 watts at zero signal output, 550 watts at rated power output into 8-ohm load

90 watts at zero signal output, 550 watts at rated power output into 8-ohm load

90 watts at zero signal output, 550 watts at rated power output into 8-ohm load

90 watts at zero signal output, 550 watts at rated power output into 8-ohm load

90 watts at zero signal output, 550 watts at rated power output into 8-ohm load

90 watts at zero signal output, 550 watts at rated power output into 8-ohm load

● DIMENSIONS:

445 mm (17-1/2 inches) width, 160mm (6-5/16 inches) max. height, 370 mm (14-9/16 inches) depth

445 mm (17-1/2 inches) width, 160mm (6-5/16 inches) max. height, 370 mm (14-9/16 inches) depth

445 mm (17-1/2 inches) width, 160mm (6-5/16 inches) max. height, 370 mm (14-9/16 inches) depth

445 mm (17-1/2 inches) width, 160mm (6-5/16 inches) max. height, 370 mm (14-9/16 inches) depth

445 mm (17-1/2 inches) width, 160mm (6-5/16 inches) max. height, 370 mm (14-9/16 inches) depth

445 mm (17-1/2 inches) width, 160mm (6-5/16 inches) max. height, 370 mm (14-9/16 inches) depth

445 mm (17-1/2 inches) width, 160mm (6-5/16 inches) max. height, 370 mm (14-9/16 inches) depth

445 mm (17-1/2 inches) width, 160mm (6-5/16 inches) max. height, 370 mm (14-9/16 inches) depth

445 mm (17-1/2 inches) width, 160mm (6-5/16 inches) max. height, 370 mm (14-9/16 inches) depth

445 mm (17-1/2 inches) width, 160mm (6-5/16 inches) max. height, 370 mm (14-9/16 inches) depth

445 mm (17-1/2 inches) width, 160mm (6-5/16 inches) max. height, 370 mm (14-9/16 inches) depth

445 mm (17-1/2 inches) width, 160mm (6-5/16 inches) max. height, 370 mm (14-9/16 inches) depth

445 mm (17-1/2 inches) width, 160mm (6-5/16 inches) max. height, 370 mm (14-9/16 inches) depth

445 mm (17-1/2 inches) width, 160mm (6-5/16 inches) max. height, 370 mm (14-9/16 inches) depth

445 mm (17-1/2 inches) width, 160mm (6-5/16 inches) max. height, 370 mm (14-9/16 inches) depth

445 mm (17-1/2 inches) width, 160mm (6-5/16 inches) max. height, 370 mm (14-9/16 inches) depth

445 mm (17-1/2 inches) width, 160mm (6-5/16 inches) max. height, 370 mm (14-9/16 inches) depth

445 mm (17-1/2 inches) width, 160mm (6-5/16 inches) max. height, 370 mm (14-9/16 inches) depth

445 mm (17-1/2 inches) width, 160mm (6-5/16 inches) max. height, 370 mm (14-9/16 inches) depth

445 mm (17-1/2 inches) width, 160mm (6-5/16 inches) max. height, 370 mm (14-9/16 inches) depth

445 mm (17-1/2 inches) width, 160mm (6-5/16 inches) max. height, 370 mm (14-9/16 inches) depth

445 mm (17-1/2 inches) width, 160mm (6-5/16 inches) max. height, 370 mm (14-9/16 inches) depth

445 mm (17-1/2 inches) width, 160mm (6-5/16 inches) max. height, 370 mm (14-9/16 inches) depth

445 mm (17-1/2 inches) width, 160mm (6-5/16 inches) max. height, 370 mm (14-9/16 inches) depth

445 mm (17-1/2 inches) width, 160mm (6-5/16 inches) max. height, 370 mm (14-9/16 inches) depth

445 mm (17-1/2 inches) width, 160mm (6-5/16 inches) max. height, 370 mm (14-9/16 inches) depth

445 mm (17-1/2 inches) width, 160mm (6-5/16 inches) max. height, 370 mm (14-9/16 inches) depth

445 mm (17-1/2 inches) width, 160mm (6-5/16 inches) max. height, 370 mm (14-9/16 inches) depth

445 mm (17-1/2 inches) width, 160mm (6-5/16 inches) max. height, 370 mm (14-9/16 inches) depth

445 mm (17-1/2 inches) width, 160mm (6-5/16 inches) max. height, 370 mm (14-9/16 inches) depth